

## Quad 12MHz Rail-to-Rail Input-Output Buffer

The EL5421 is a quad, low power, high voltage rail-to-rail input-output buffer.

Operating on supplies ranging from 5V to 15V, while consuming only 500 $\mu$ A per channel, the EL5421 has a bandwidth of 12MHz (-3dB). The EL5421 also provides rail-to-rail input and output ability, giving the maximum dynamic range at any supply voltage.

The EL5421 also features fast slewing and settling times, as well as a high output drive capability of 30mA (sink and source). These features make the EL5421 ideal for use as voltage reference buffers in Thin Film Transistor Liquid Crystal Displays (TFT-LCD). Other applications include battery power, portable devices and anywhere low power consumption is important.

The EL5421 is available in a space saving 10 Ld MSOP package and operates over a temperature range of -40°C to +85°C.

### Pinout

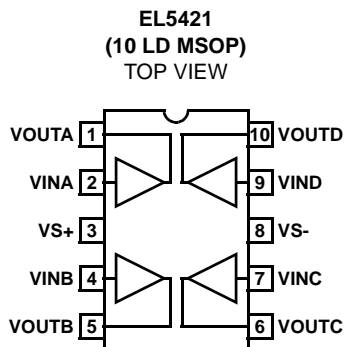

### Features

- 12MHz -3dB bandwidth
- Unity gain buffer
- Supply voltage = 4.5V to 16.5V
- Low supply current (per buffer) = 500 $\mu$ A
- High slew rate = 10V/ $\mu$ s
- Rail-to-rail operation
- "Mini" SO package (MSOP)
- Pb-free plus anneal available (RoHS compliant)

### Applications

- TFT-LCD drive circuits
- Electronics notebooks
- Electronics games
- Personal communication devices
- Personal digital assistants (PDA)
- Portable instrumentation
- Wireless LANs
- Office automation
- Active filters
- ADC/DAC buffers

### Ordering Information

PART NUMBER	PART MARKING	PACKAGE	PKG. DWG. #
EL5421CY	F	10 Ld MSOP	MDP0043
EL5421CY-T7*	F	10 Ld MSOP	MDP0043
EL5421CY-T13*	F	10 Ld MSOP	MDP0043
EL5421CYZ (Note)	BCAAA	10 Ld MSOP (Pb-Free)	MDP0043
EL5421CYZ-T7* (Note)	BCAAA	10 Ld MSOP (Pb-Free)	MDP0043
EL5421CYZ-T13* (Note)	BCAAA	10 Ld MSOP (Pb-Free)	MDP0043

\*Please refer to TB347 for details on reel specifications.

NOTE: Intersil Pb-free plus anneal products employ special Pb-free material sets; molding compounds/die attach materials and 100% matte tin plate termination finish, which are RoHS compliant and compatible with both SnPb and Pb-free soldering operations. Intersil Pb-free products are MSL classified at Pb-free peak reflow temperatures that meet or exceed the Pb-free requirements of IPC/JEDEC J STD-020.

**Absolute Maximum Ratings** ( $T_A = +25^\circ\text{C}$ )

Supply Voltage between  $V_{S+}$  and  $V_{S-}$  ..... +18V  
 Input Voltage .....  $V_{S-} - 0.5\text{V}$ ,  $V_{S+} + 0.5\text{V}$   
 Maximum Continuous Output Current ..... 30mA

**Thermal Information**

Storage Temperature .....  $-65^\circ\text{C}$  to  $+150^\circ\text{C}$   
 Operating Temperature .....  $-40^\circ\text{C}$  to  $+85^\circ\text{C}$   
 Power Dissipation ..... See Curves  
 Maximum Die Temperature .....  $+125^\circ\text{C}$   
 Pb-free reflow profile ..... see link below  
<http://www.intersil.com/pbfree/Pb-FreeReflow.asp>

*CAUTION: Do not operate at or near the maximum ratings listed for extended periods of time. Exposure to such conditions may adversely impact product reliability and result in failures not covered by warranty.*

**Electrical Specifications**  $V_{S+} = +5\text{V}$ ,  $V_{S-} = -5\text{V}$ ,  $R_L = 10\text{k}\Omega$  and  $C_L = 10\text{pF}$  to  $0\text{V}$ ,  $T_A = +25^\circ\text{C}$  unless otherwise specified.

PARAMETER	DESCRIPTION	CONDITION	MIN (Note 4)	TYP	MAX (Note 4)	UNIT
<b>INPUT CHARACTERISTICS</b>						
$V_{OS}$	Input Offset Voltage	$V_{CM} = 0\text{V}$		2	12	mV
$TCV_{OS}$	Average Offset Voltage Drift	(Note 1)		5		$\mu\text{V}/^\circ\text{C}$
$I_B$	Input Bias Current	$V_{CM} = 0\text{V}$		2	50	nA
$R_{IN}$	Input Impedance			1		$\text{G}\Omega$
$C_{IN}$	Input Capacitance			1.35		pF
$A_V$	Voltage Gain	$-4.5\text{V} \leq V_{OUT} \leq 4.5\text{V}$	0.995		1.005	V/V
<b>OUTPUT CHARACTERISTICS</b>						
$V_{OL}$	Output Swing Low	$I_L = -5\text{mA}$		-4.92	-4.85	V
$V_{OH}$	Output Swing High	$I_L = 5\text{mA}$	4.85	4.92		V
$I_{SC}$	Short Circuit Current	Short to GND (Note 2)	$\pm 80$	$\pm 120$		mA
<b>POWER SUPPLY PERFORMANCE</b>						
PSRR	Power Supply Rejection Ratio	$V_S$ is moved from $\pm 2.25\text{V}$ to $\pm 7.75\text{V}$	60	80		dB
$I_S$	Supply Current (Per Buffer)	No load		500	750	$\mu\text{A}$
<b>DYNAMIC PERFORMANCE</b>						
SR	Slew Rate (Note 3)	$-4.0\text{V} \leq V_{OUT} \leq 4.0\text{V}$ , 20% to 80%	7	10		$\text{V}/\mu\text{s}$
$t_S$	Settling to +0.1%	$V_O = 2\text{V}$ step		500		ns
BW	-3dB Bandwidth	$R_L = 10\text{k}\Omega$ , $C_L = 10\text{pF}$		12		MHz
CS	Channel Separation	$f = 5\text{MHz}$		75		dB

# EL5421

**Electrical Specifications**  $V_{S+} = +5V$ ,  $V_{S-} = 0V$ ,  $R_L = 10k\Omega$  and  $C_L = 10pF$  to 2.5V,  $T_A = +25^\circ C$  unless otherwise specified.

PARAMETER	DESCRIPTION	CONDITION	MIN (Note 4)	TYP	MAX (Note 4)	UNIT
<b>INPUT CHARACTERISTICS</b>						
$V_{OS}$	Input Offset Voltage	$V_{CM} = 2.5V$		2	10	mV
$TCV_{OS}$	Average Offset Voltage Drift	(Note 1)		5		$\mu V/^\circ C$
$I_B$	Input Bias Current	$V_{CM} = 2.5V$		2	50	nA
$R_{IN}$	Input Impedance			1		GW
$C_{IN}$	Input Capacitance			1.35		pF
$A_V$	Voltage Gain	$0.5 \leq V_{OUT} \leq 4.5V$	0.995		1.005	V/V
<b>OUTPUT CHARACTERISTICS</b>						
$V_{OL}$	Output Swing Low	$I_L = -5mA$		80	150	mV
$V_{OH}$	Output Swing High	$I_L = 5mA$	4.85	4.92		V
$I_{SC}$	Short Circuit Current	Short to GND (Note 2)	$\pm 80$	$\pm 120$		mA
<b>POWER SUPPLY PERFORMANCE</b>						
PSRR	Power Supply Rejection Ratio	$V_S$ is moved from 4.5V to 15.5V	60	80		dB
$I_S$	Supply Current (Per Buffer)	No load		500	750	$\mu A$
<b>DYNAMIC PERFORMANCE</b>						
SR	Slew Rate (Note 3)	$1V \leq V_{OUT} \leq 4V$ , 20% to 80%	7	10		$V/\mu s$
$t_S$	Settling to +0.1%	$V_O = 2V$ step		500		ns
BW	-3dB Bandwidth	$R_L = 10k\Omega$ , $C_L = 10pF$		12		MHz
CS	Channel Separation	$f = 5MHz$		75		dB

# EL5421

**Electrical Specifications**  $V_{S+} = +15V$ ,  $V_{S-} = 0V$ ,  $R_L = 10k\Omega$  and  $C_L = 10pF$  to 7.5V,  $T_A = +25^\circ C$  unless otherwise specified.

PARAMETER	DESCRIPTION	CONDITION	MIN (Note 4)	TYP	MAX (Note 4)	UNIT
<b>INPUT CHARACTERISTICS</b>						
$V_{OS}$	Input Offset Voltage	$V_{CM} = 7.5V$		2	14	mV
$TCV_{OS}$	Average Offset Voltage Drift	(Note 1)		5		$\mu V/^\circ C$
$I_B$	Input Bias Current	$V_{CM} = 7.5V$		2	50	nA
$R_{IN}$	Input Impedance			1		$G\Omega$
$C_{IN}$	Input Capacitance			1.35		pF
$A_V$	Voltage Gain	$0.5 \leq V_{OUT} \leq 14.5V$	0.995		1.005	V/V
<b>OUTPUT CHARACTERISTICS</b>						
$V_{OL}$	Output Swing Low	$I_L = -5mA$		80	150	mV
$V_{OH}$	Output Swing High	$I_L = 5mA$	14.85	14.92		V
$I_{SC}$	Short Circuit Current	Short to GND (Note 2)	$\pm 80$	$\pm 120$		mA
<b>POWER SUPPLY PERFORMANCE</b>						
PSRR	Power Supply Rejection Ratio	$V_S$ is moved from 4.5V to 15.5V	60	80		dB
$I_S$	Supply Current (Per Buffer)	No load		500	750	$\mu A$
<b>DYNAMIC PERFORMANCE</b>						
SR	Slew Rate (Note 3)	$1V \leq V_{OUT} \leq 14V$ , 20% to 80%	7	10		$V/\mu s$
$t_S$	Settling to +0.1%	$V_O = 2V$ step		500		ns
BW	-3dB Bandwidth	$R_L = 10k\Omega$ , $C_L = 10pF$		12		MHz
CS	Channel Separation	$f = 5MHz$		75		dB

**NOTES:**

1. Measured over the operating temperature range
2. Limits established by characterization and are not production tested.
3. Slew rate is measured on rising and falling edges
4. Parts are 100% tested at +25°C. Over-temperature limits established by characterization and are not production tested

Typical Performance Curves

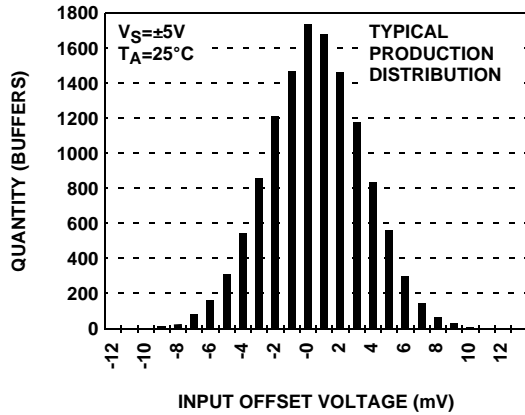

FIGURE 1. INPUT OFFSET VOLTAGE DISTRIBUTION

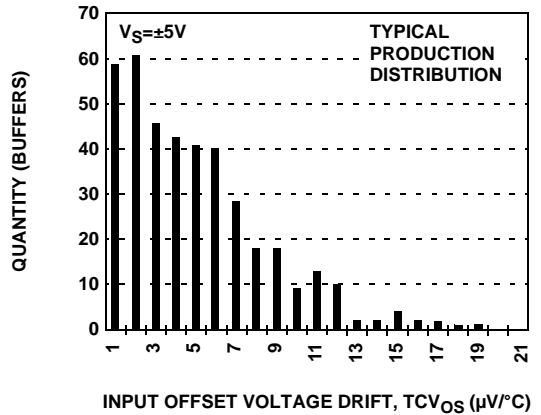

FIGURE 2. INPUT OFFSET VOLTAGE DRIFT

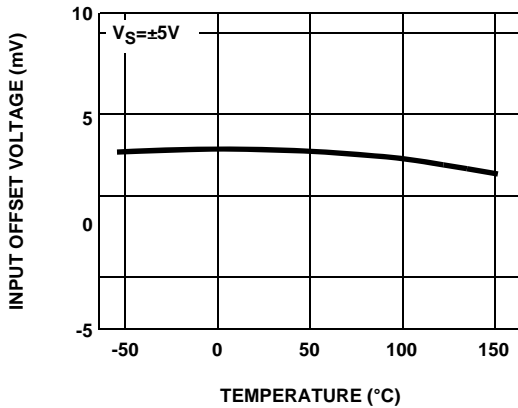

FIGURE 3. INPUT OFFSET VOLTAGE vs TEMPERATURE

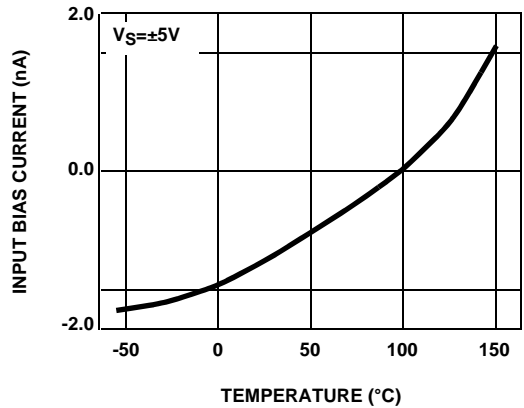

FIGURE 4. INPUT BIAS CURRENT vs TEMPERATURE

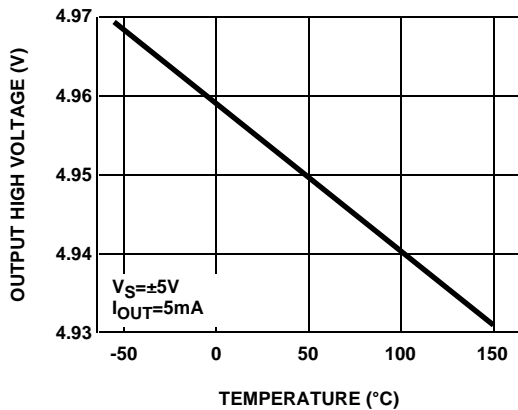

FIGURE 5. OUTPUT HIGH VOLTAGE vs TEMPERATURE

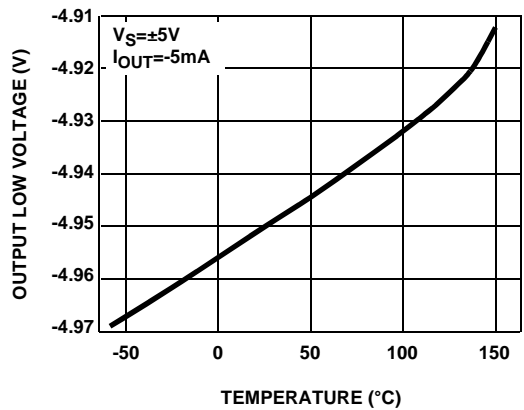

FIGURE 6. OUTPUT LOW VOLTAGE vs TEMPERATURE

Typical Performance Curves

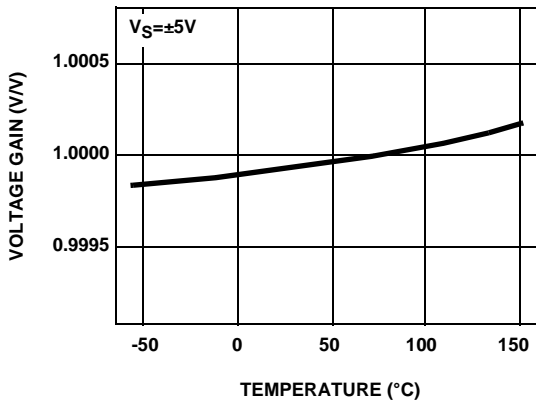

FIGURE 7. VOLTAGE GAIN vs TEMPERATURE

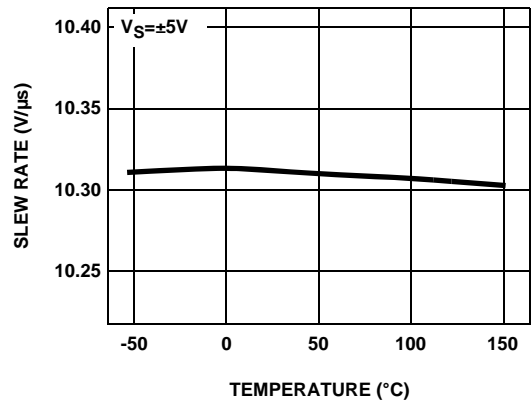

FIGURE 8. SLEW RATE vs TEMPERATURE

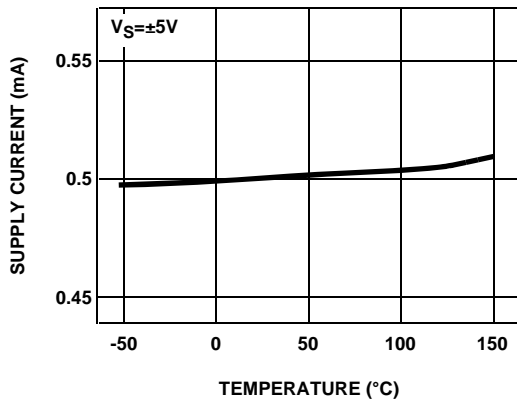

FIGURE 9. SUPPLY CURRENT PER CHANNEL vs TEMPERATURE

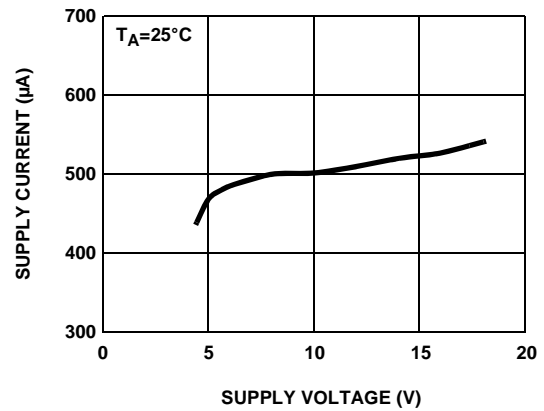

FIGURE 10. SUPPLY CURRENT PER CHANNEL vs SUPPLY VOLTAGE

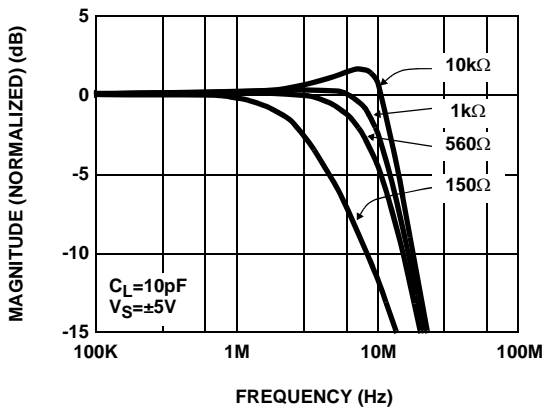

FIGURE 11. FREQUENCY RESPONSE FOR VARIOUS  $R_L$

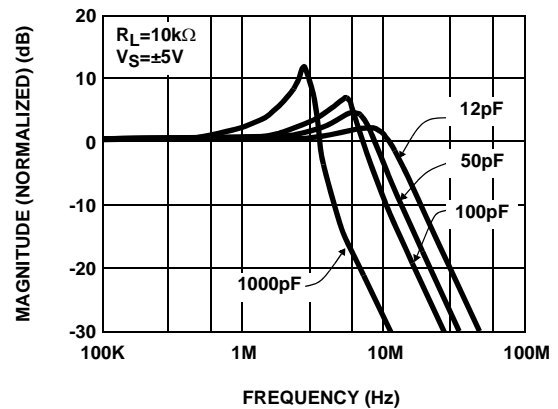

FIGURE 12. FREQUENCY RESPONSE FOR VARIOUS  $C_L$

Typical Performance Curves

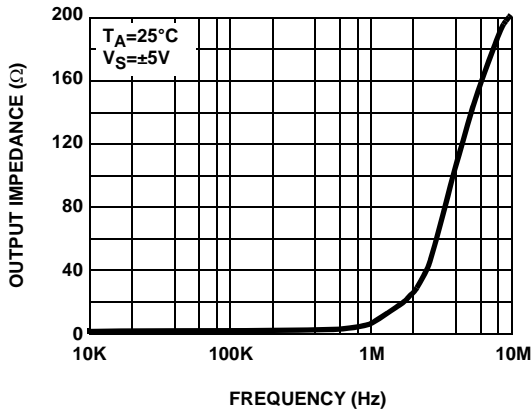

FIGURE 13. OUT PUT IMPEDANCE vs FREQUENCY

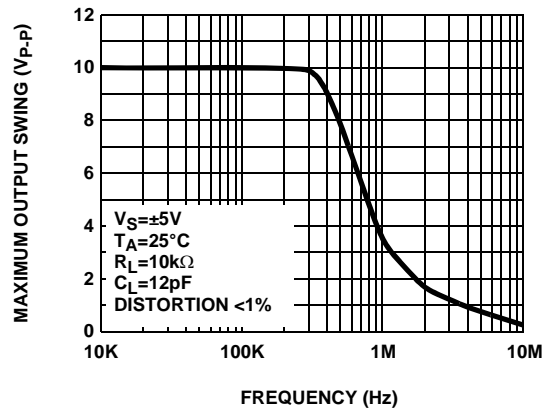

FIGURE 14. MAXIMUM OUTPUT SWING vs FREQUENCY

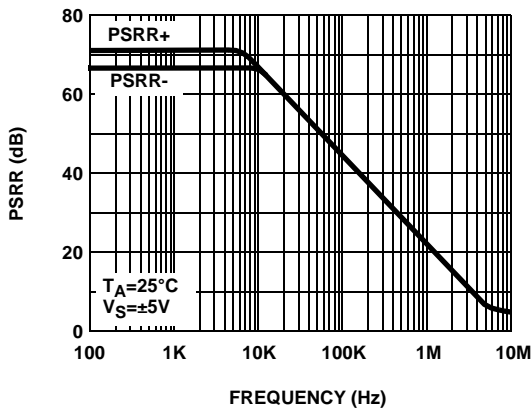

FIGURE 15. PSRR vs FREQUENCY

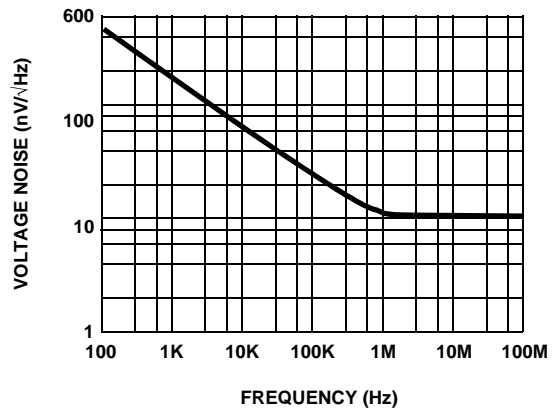

FIGURE 16. INPUT VOLTAGE NOISE SPECTRAL DENSITY vs FREQUENCY

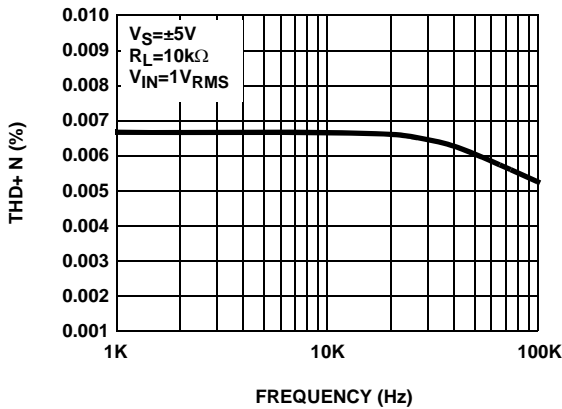

FIGURE 17. TOTAL HARMONIC DISTORTION + NOISE vs FREQUENCY

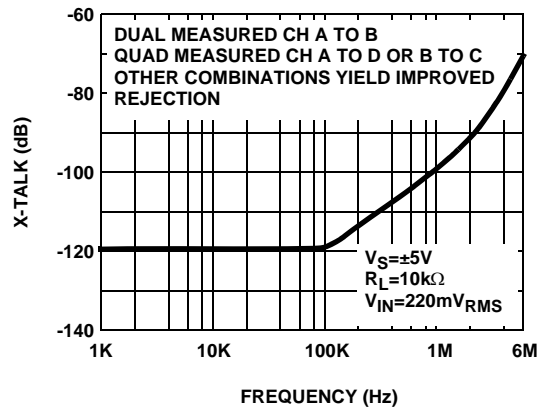

FIGURE 18. CHANNEL SEPARATION vs FREQUENCY RESPONSE

Typical Performance Curves

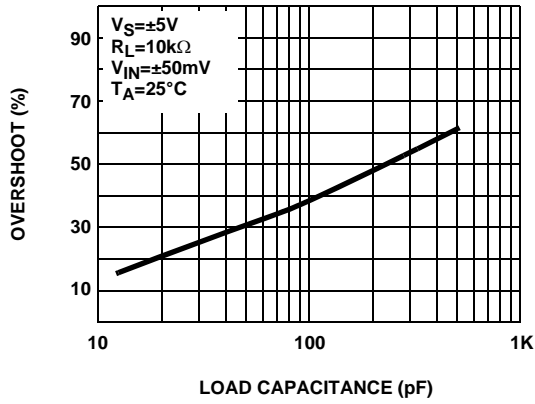

FIGURE 19. SMALL SIGNAL OVERSHOOT vs LOAD CAPACITANCE

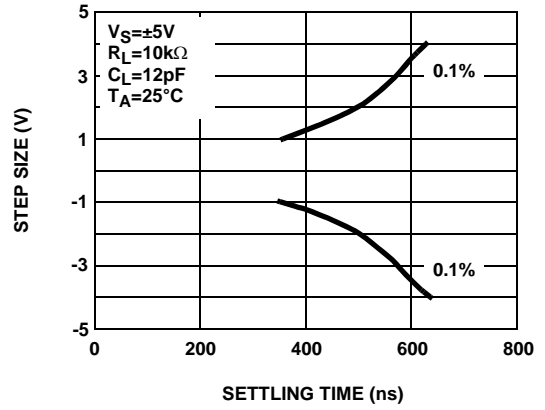

FIGURE 20. SETTLING TIME vs STEP SIZE

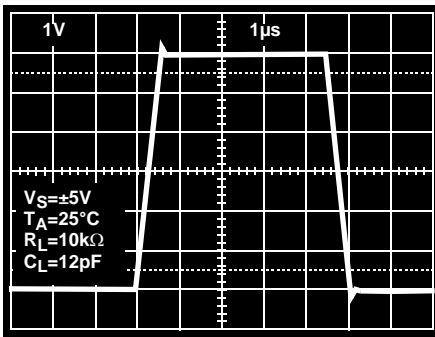

FIGURE 21. LARGE SIGNAL TRANSIENT RESPONSE

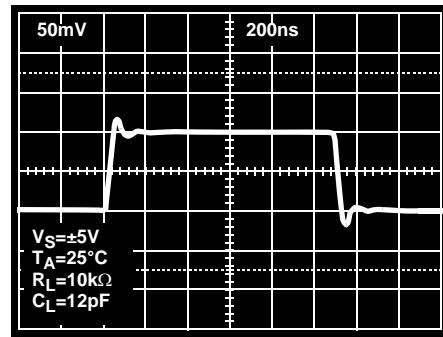
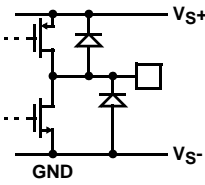
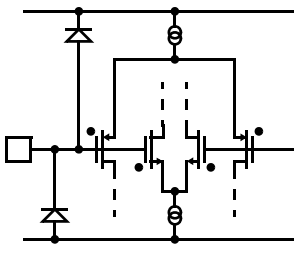

FIGURE 22. SMALL SIGNAL TRANSIENT RESPONSE



**Pin Descriptions**

PIN NUMBER	PIN NAME	FUNCTION	EQUIVALENT CIRCUIT
1	VOUTA	Buffer A Output	 <p>CIRCUIT 1</p>
2	VINA	Buffer A Input	 <p>CIRCUIT 2</p>
3	VS+	Positive Power Supply	
4	VINB	Buffer B Input	(Reference Circuit 1)
5	VOUTB	Buffer B Output	(Reference Circuit 2)
6	VOUTC	Buffer C Output	(Reference Circuit 2)
7	VINC	Buffer C Input	(Reference Circuit 1)
8	VS-	Negative Power Supply	
9	VIND	Buffer D Input	(Reference Circuit 2)
10	VOUTD	Buffer D Output	(Reference Circuit 1)

**Applications Information**

**Product Description**

The EL5421 unity gain buffer is fabricated using a high voltage CMOS process. It exhibits rail-to-rail input and output capability, and has low power consumption (500µA per buffer). These features make the EL5421 ideal for a wide range of general-purpose applications. When driving a load of 10kΩ and 12pF, the EL5421 has a -3dB bandwidth of 12MHz and exhibits 10V/µs slew rate.

**Operating Voltage, Input, and Output**

The EL5421 is specified with a single nominal supply voltage from 5V to 15V or a split supply with its total range from 5V to 15V. Correct operation is guaranteed for a supply range of 4.5V to 16.5V. Most EL5421 specifications are stable over both the full supply range and operating temperatures of -40°C to +85°C. Parameter variations with operating voltage and/or temperature are shown in the typical performance curves.

The output swings of the EL5421 typically extend to within 80mV of positive and negative supply rails with load currents of 5mA. Decreasing load currents will extend the output

voltage range even closer to the supply rails. Figure 23 shows the input and output waveforms for the device. Operation is from ±5V supply with a 10kΩ load connected to GND. The input is a 10V<sub>P-P</sub> sinusoid. The output voltage is approximately 9.985V<sub>P-P</sub>.

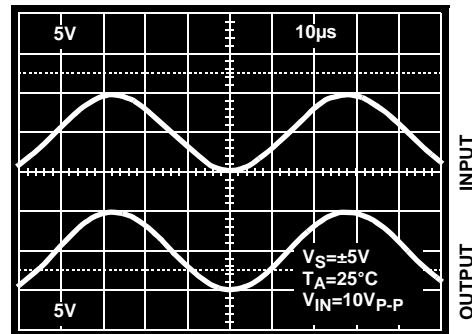

FIGURE 23. OPERATION WITH RAIL-TO-RAIL INPUT AND OUTPUT

**Short Circuit Current Limit**

The EL5421 will limit the short circuit current to ±120mA if the output is directly shorted to the positive or the negative supply. If an output is shorted indefinitely, the power

dissipation could easily increase such that the device may be damaged. Maximum reliability is maintained if the output continuous current never exceeds  $\pm 30\text{mA}$ . This limit is set by the design of the internal metal interconnects.

**Output Phase Reversal**

The EL5421 is immune to phase reversal as long as the input voltage is limited from  $V_S - 0.5\text{V}$  to  $V_S + 0.5\text{V}$ . Figure 24 shows a photo of the output of the device with the input voltage driven beyond the supply rails. Although the device's output will not change phase, the input's overvoltage should be avoided. If an input voltage exceeds supply voltage by more than 0.6V, electrostatic protection diodes placed in the input stage of the device begin to conduct and overvoltage damage could occur.

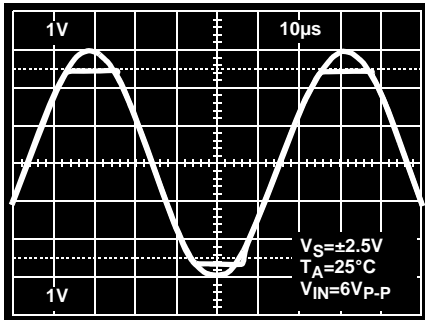

FIGURE 24. OPERATION WITH BEYOND-THE-RAILS INPUT

**Power Dissipation**

With the high-output drive capability of the EL5421 buffer, it is possible to exceed the  $+125^\circ\text{C}$  'absolute-maximum junction temperature' under certain load current conditions. Therefore, it is important to calculate the maximum junction temperature for the application to determine if load conditions need to be modified for the buffer to remain in the safe operating area.

The maximum power dissipation allowed in a package is determined according to:

$$P_{\text{DMAX}} = \frac{T_{\text{JMAX}} - T_{\text{AMAX}}}{\theta_{\text{JA}}} \quad (\text{EQ. 1})$$

where:

- $T_{\text{JMAX}}$  = Maximum junction temperature
- $T_{\text{AMAX}}$  = Maximum ambient temperature
- $\theta_{\text{JA}}$  = Thermal resistance of the package
- $P_{\text{DMAX}}$  = Maximum power dissipation in the package

The maximum power dissipation actually produced by an IC is the total quiescent supply current times the total power supply voltage, plus the power in the IC due to the loads, or:

$$P_{\text{DMAX}} = \sum_i [V_S \times I_{\text{SMAX}} + (V_S + V_{\text{OUT}i}) \times I_{\text{LOAD}i}] \quad (\text{EQ. 2})$$

when sourcing, and:

$$P_{\text{DMAX}} = \sum_i [V_S \times I_{\text{SMAX}} + (V_{\text{OUT}i} - V_S) \times I_{\text{LOAD}i}] \quad (\text{EQ. 3})$$

when sinking.

Where:

$i = 1$  to 4 for quad

$V_S$  = Total supply voltage

$I_{\text{SMAX}}$  = Maximum supply current per channel

$V_{\text{OUT}i}$  = Maximum output voltage of the application

$I_{\text{LOAD}i}$  = Load current

If we set the two  $P_{\text{DMAX}}$  equations equal to each other, we can solve for  $R_{\text{LOAD}i}$  to avoid device overheat. Figures 25 and 26 provide a convenient way to see if the device will overheat. The maximum safe power dissipation can be found graphically, based on the package type and the ambient temperature. By using the previous equation, it is a simple matter to see if  $P_{\text{DMAX}}$  exceeds the device's power derating curves. To ensure proper operation, it is important to observe the recommended derating curves shown in Figures 25 and 26.

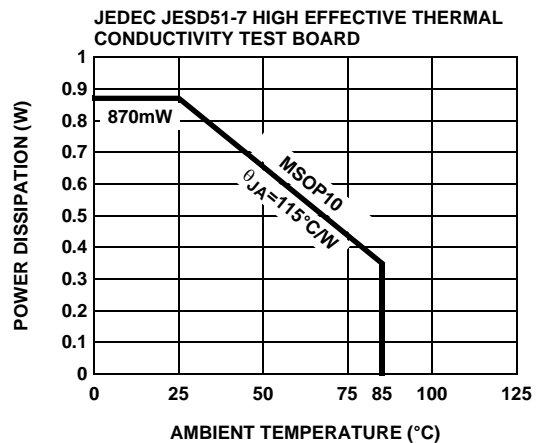

FIGURE 25. PACKAGE POWER DISSIPATION vs AMBIENT TEMPERATURE

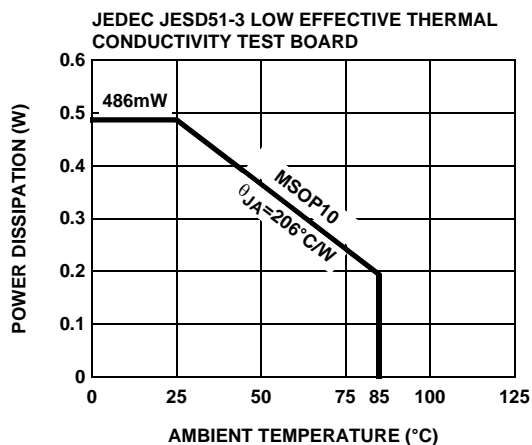

FIGURE 26. PACKAGE POWER DISSIPATION vs AMBIENT TEMPERATURE

### Unused Buffers

It is recommended that any unused buffer have the input tied to the ground plane.

### Driving Capacitive Loads

The EL5421 can drive a wide range of capacitive loads. As load capacitance increases, however, the -3dB bandwidth of the device will decrease and the peaking increase. The buffers drive 10pF loads in parallel with 10k $\Omega$  with just 1.5dB of peaking, and 100pF with 6.4dB of peaking. If less peaking is desired in these applications, a small series resistor (usually between 5 $\Omega$  and 50 $\Omega$ ) can be placed in series with the output. However, this will obviously reduce the gain slightly. Another method of reducing peaking is to add a "snubber" circuit at the output. A snubber is a shunt load consisting of a resistor in series with a capacitor. Values of 150 $\Omega$  and 10nF are typical. The advantage of a snubber is that it does not draw any DC load current or reduce the gain.

### Power Supply Bypassing and Printed Circuit Board Layout

The EL5421 can provide gain at high frequency. As with any high-frequency device, good printed circuit board layout is necessary for optimum performance. Ground plane construction is highly recommended, lead lengths should be as short as possible and the power supply pins must be well bypassed to reduce the risk of oscillation. For normal single supply operation, where the V<sub>S-</sub> pin is connected to ground, a 0.1 $\mu$ F ceramic capacitor should be placed from V<sub>S+</sub> to pin to V<sub>S-</sub> pin. A 4.7 $\mu$ F tantalum capacitor should then be connected in parallel, placed in the region of the buffer. One 4.7 $\mu$ F capacitor may be used for multiple devices. This same capacitor combination should be placed at each supply pin to ground if split supplies are to be used.

Mini SO Package Family (MSOP)

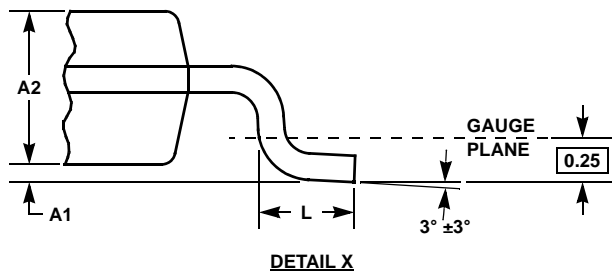
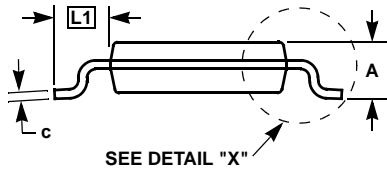
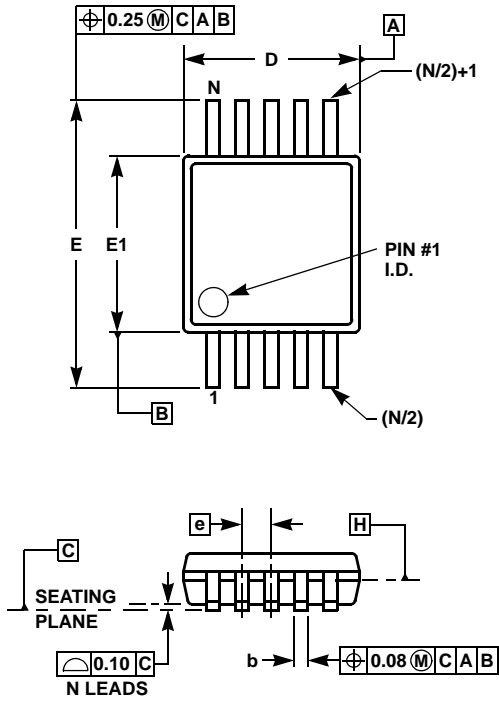

MDP0043  
MINI SO PACKAGE FAMILY

SYMBOL	MILLIMETERS		TOLERANCE	NOTES
	MSOP8	MSOP10		
A	1.10	1.10	Max.	-
A1	0.10	0.10	±0.05	-
A2	0.86	0.86	±0.09	-
b	0.33	0.23	+0.07/-0.08	-
c	0.18	0.18	±0.05	-
D	3.00	3.00	±0.10	1, 3
E	4.90	4.90	±0.15	-
E1	3.00	3.00	±0.10	2, 3
e	0.65	0.50	Basic	-
L	0.55	0.55	±0.15	-
L1	0.95	0.95	Basic	-
N	8	10	Reference	-

Rev. D 2/07

NOTES:

1. Plastic or metal protrusions of 0.15mm maximum per side are not included.
2. Plastic interlead protrusions of 0.25mm maximum per side are not included.
3. Dimensions "D" and "E1" are measured at Datum Plane "H".
4. Dimensioning and tolerancing per ASME Y14.5M-1994.